

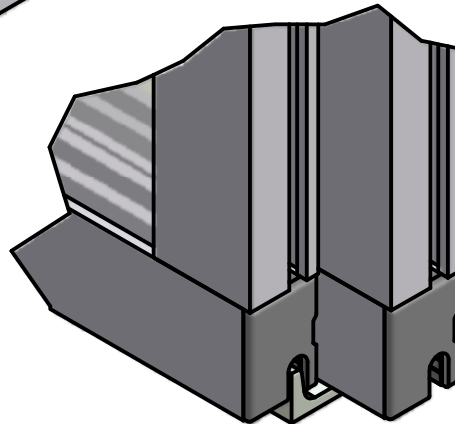

CLEAR POLYCARBONATE (LEXAN®)
DOOR PANELS

RUGGED 45X90 (1.77" X 3.54")
ALUMINUM FRAME

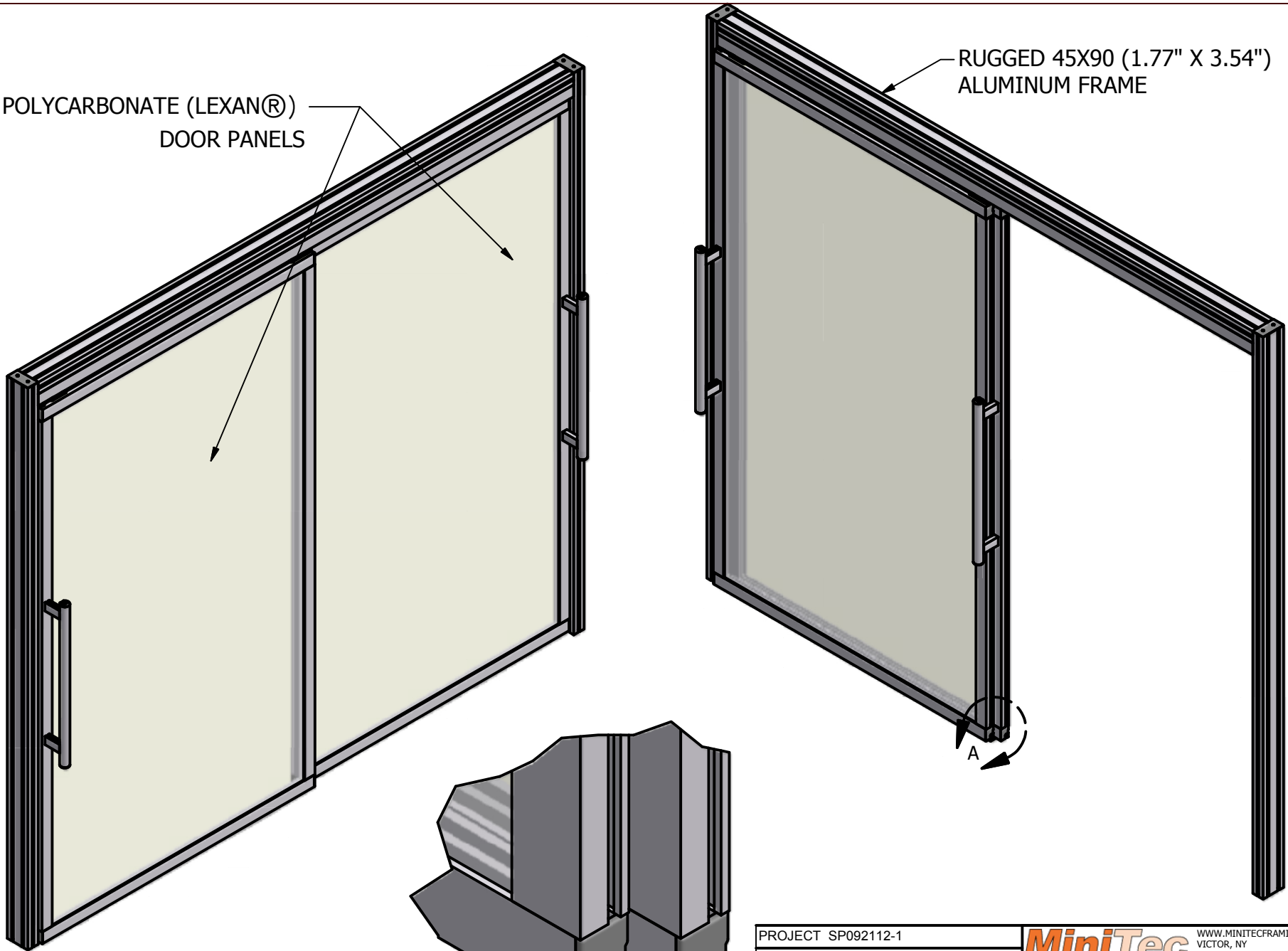

DETAIL A
SCALE .4

PROJECT SP092112-1			WWW.MINITECFRAMING.COM	
DRAWN BY ANDY MOLES			VICTOR, NY	
DATE 12/10/2012			PH # 585 924-4690 DIRECT 585 398-1240 EXT 104 FX # 585 924-4821 amoles@minitecframing.com	
DRAWN FOR MINITEC'S CUSTOMER	TITLE ADD TITLE	DWG NO SP121112-1	REV	
TOLERANCES UNLESS OTHERWISE NOTED X +/- .125" XX +/- .015" XXX +/- .010"		MATERIAL		SHEET 1 OF 7
		FINISH		

SPECIFY SP121112-1 ALONG WITH WIDTH & HEIGHT TO GET A QUOTE

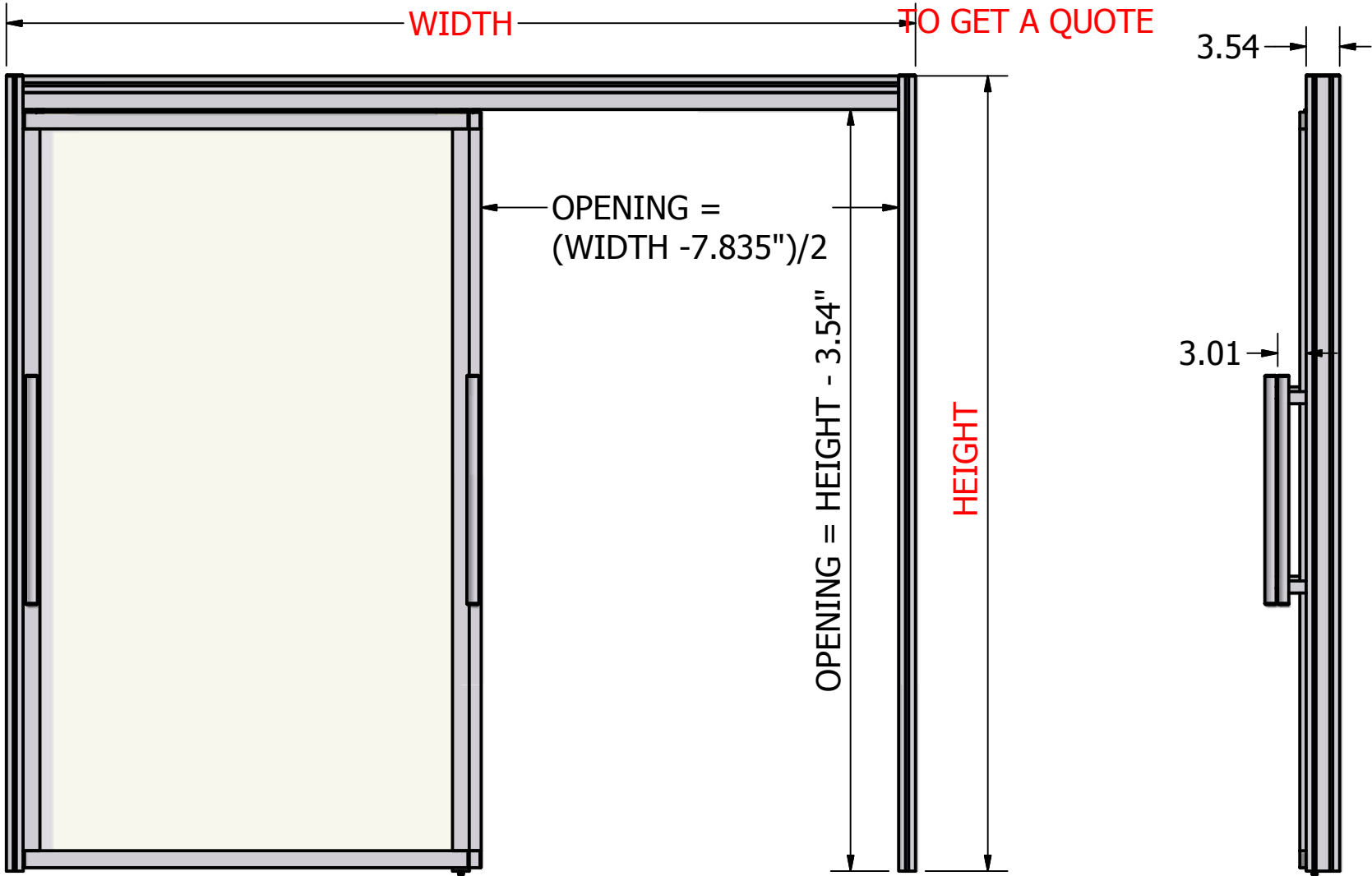

PROJECT SP092112-1		 <small>WWW.MINITECFRAMING.COM VICTOR, NY PH # 585 924-4690 DIRECT 585 398-1240 EXT 104 FX # 585 924-4821 amoles@minitecframing.com</small>	
DRAWN BY ANDY MOLES			
DATE 12/10/2012			
DRAWN FOR MINITEC'S CUSTOMER	TITLE ADD TITLE	DWG NO SP121112-1	REV
<small>TOLERANCES UNLESS OTHERWISE NOTED X +/- .125" .XX +/- .015" .XXX +/- .010"</small>		MATERIAL	SHEET 2 OF 7
		FINISH	

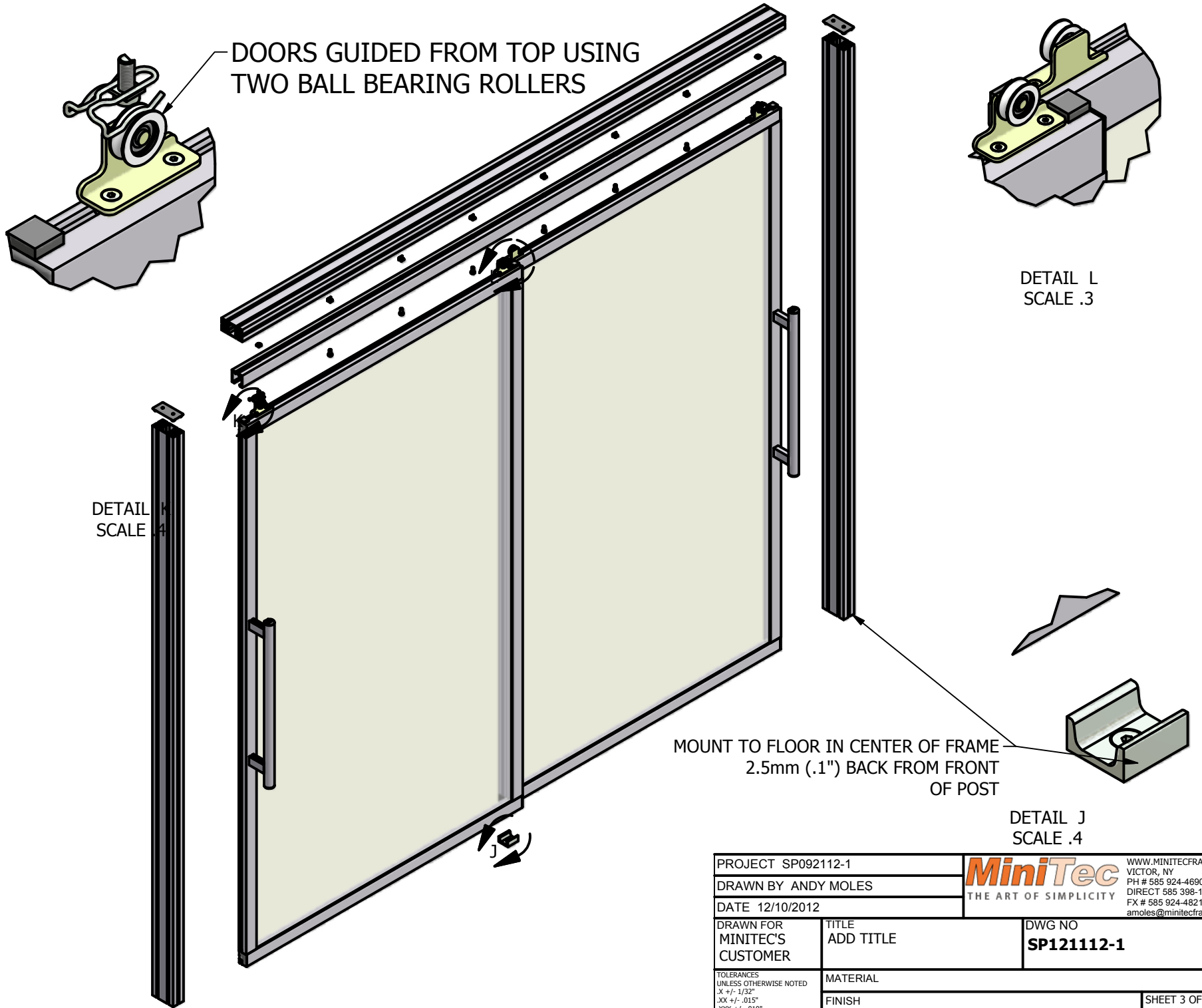

PROJECT SP092112-1		 <small>THE ART OF SIMPLICITY</small>	<small>WWW.MINITECFRAMING.COM</small> <small>VICTOR, NY</small> <small>PH # 585 924-4690</small> <small>DIRECT 585 398-1240 EXT 104</small> <small>FX # 585 924-4821</small> <small>amoles@minitecframing.com</small>	
DRAWN BY ANDY MOLES				
DATE 12/10/2012				
DRAWN FOR MINITEC'S CUSTOMER	TITLE ADD TITLE	DWG NO SP121112-1	REV	
<small>TOLERANCES UNLESS OTHERWISE NOTED</small> <small>.X +/- .1/32"</small> <small>.XX +/- .015"</small> <small>.XXX +/- .010"</small>		MATERIAL	FINISH	
				SHEET 3 OF 7

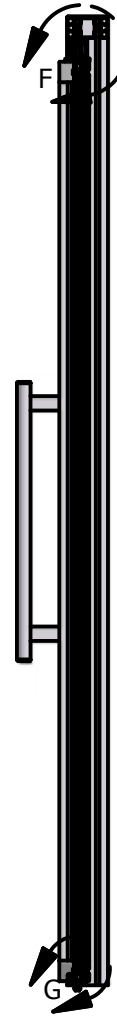
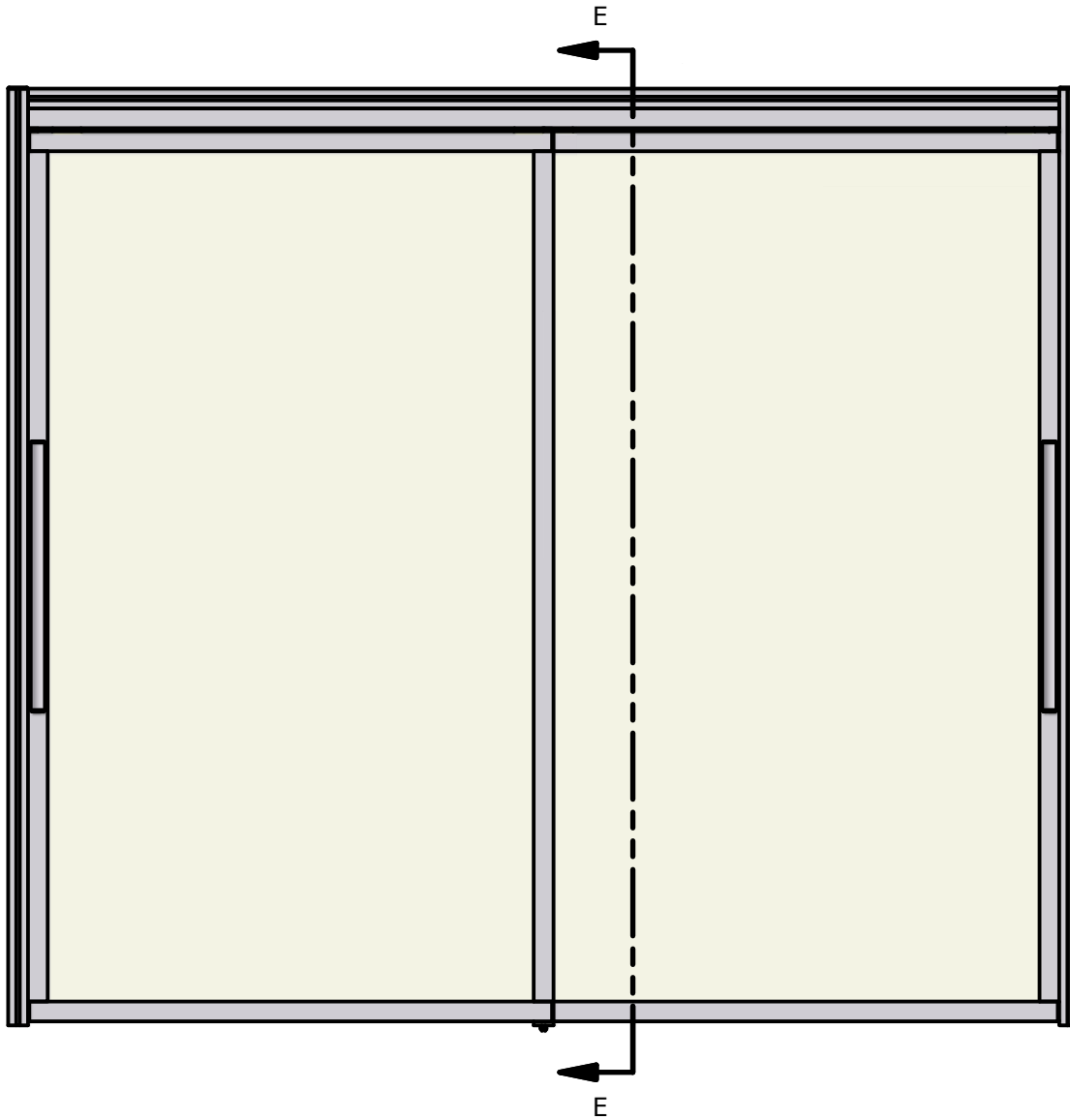

SECTION E-E
SCALE .06

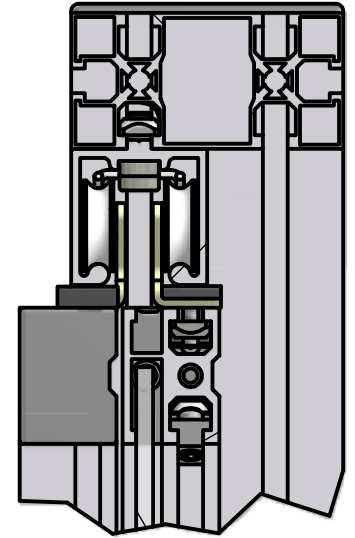

DETAIL F
SCALE .4

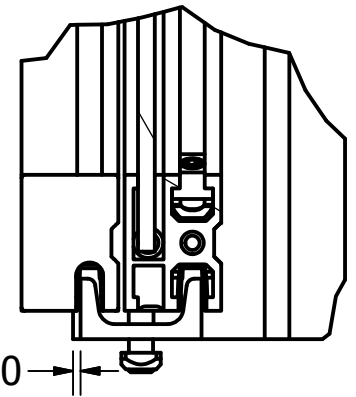

DETAIL G
SCALE .4

PROJECT SP092112-1			WWW.MINITECFRAMING.COM	
DRAWN BY ANDY MOLES			VICTOR, NY	
DATE 12/10/2012			PH # 585 924-4690	
DRAWN FOR MINITEC'S CUSTOMER		DIRECT 585 398-1240 EXT 104		FX # 585 924-4821
TITLE ADD TITLE		DWG NO SP121112-1		REV
TOLERANCES UNLESS OTHERWISE NOTED X +/- .12" .XX +/- .015" .XXX +/- .010"		MATERIAL		SHEET 4 OF 7
FINISH				

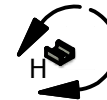
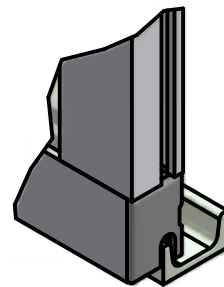
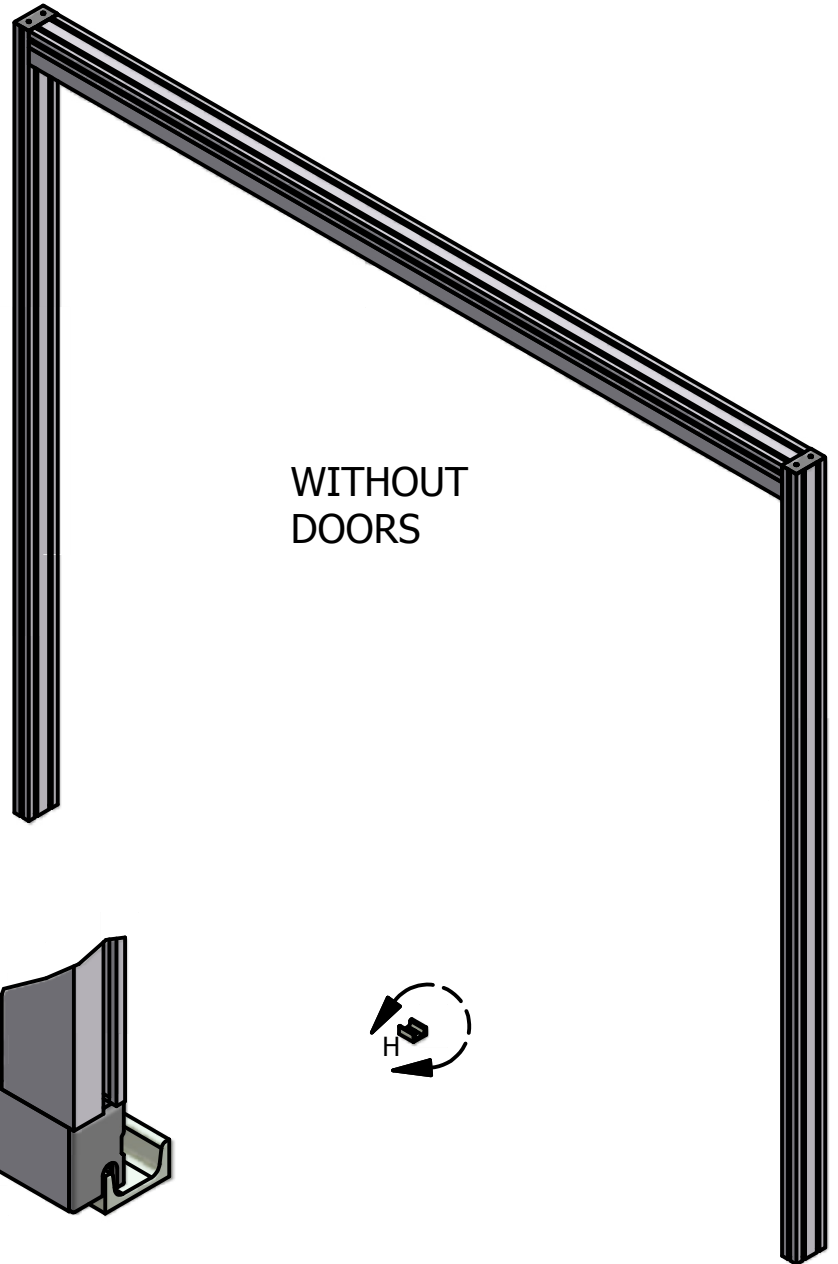
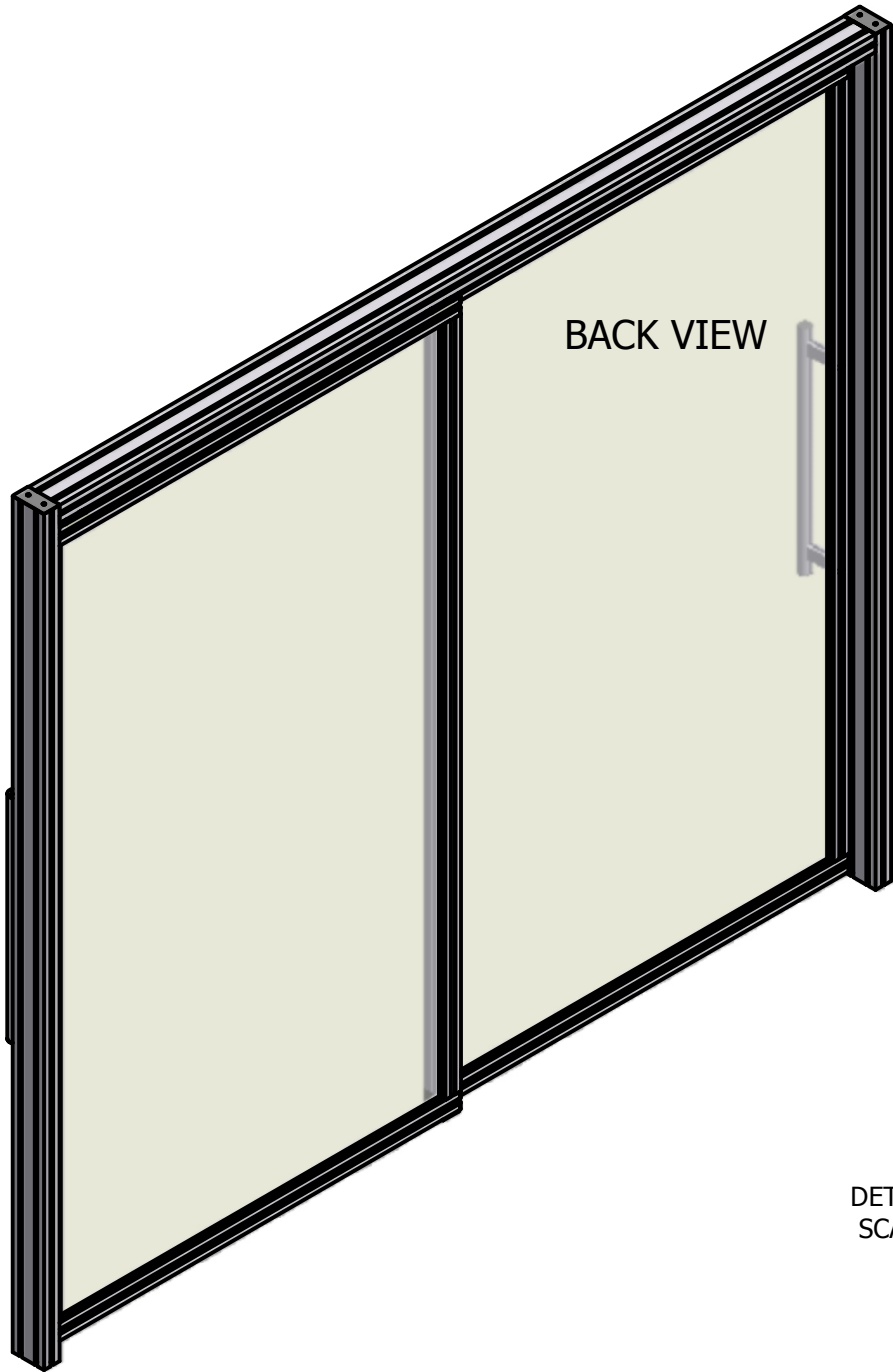

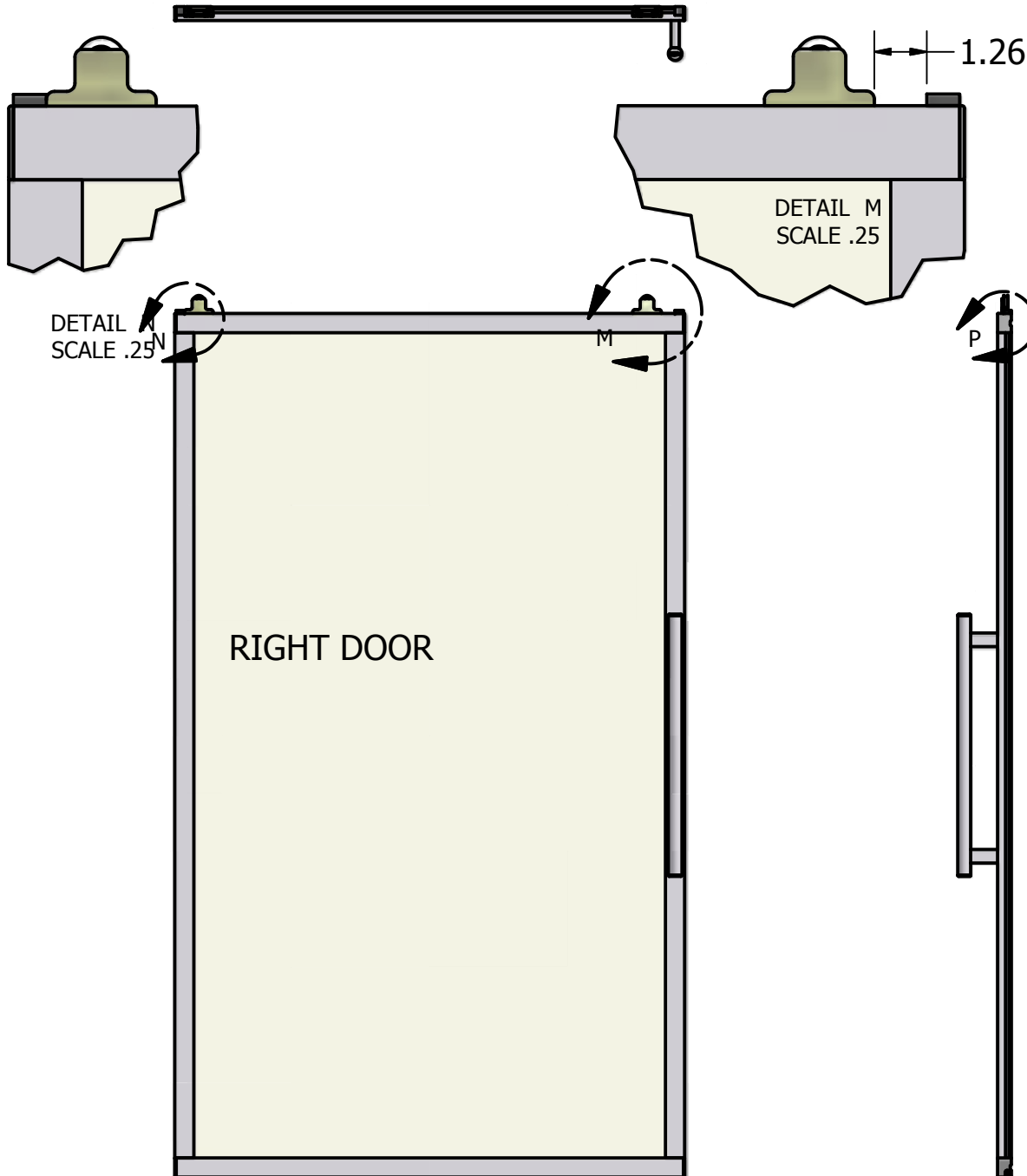

DETAIL H
SCALE .3

PROJECT SP092112-1		 <small>WWW.MINITECFRAMING.COM VICTOR, NY PH # 585 924-4690 DIRECT 585 398-1240 EXT 104 FX # 585 924-4821 amoles@minitecframing.com</small>	
DRAWN BY ANDY MOLES			
DATE 12/10/2012			
DRAWN FOR MINITEC'S CUSTOMER	TITLE ADD TITLE	DWG NO SP121112-1	REV
<small>TOLERANCES UNLESS OTHERWISE NOTED X +/- .125" .XX +/- .015" .XXX +/- .010"</small>		MATERIAL	
		FINISH	SHEET 5 OF 7

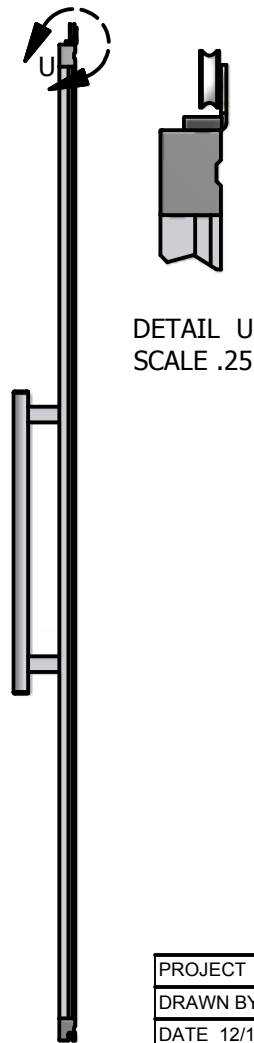
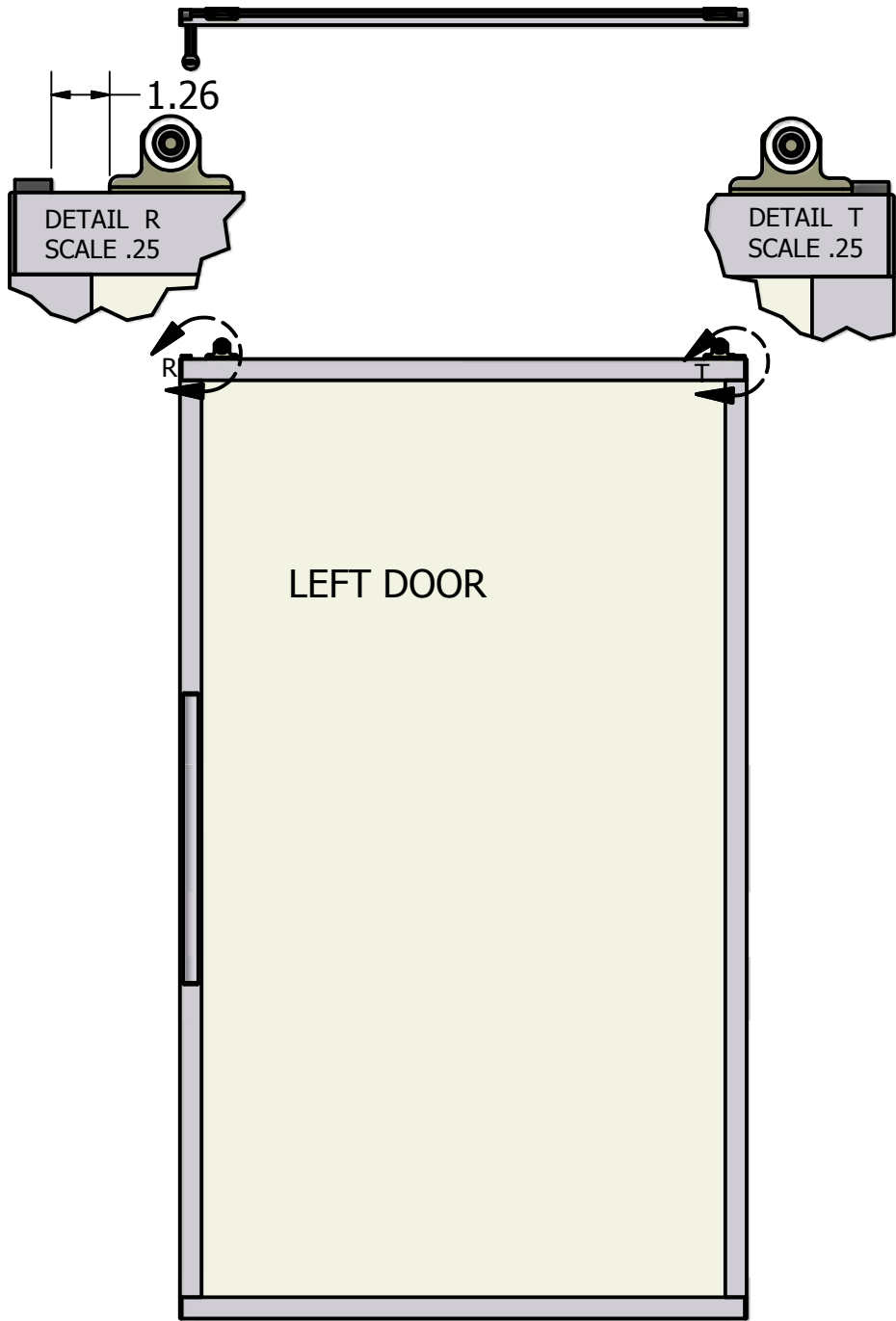

PROJECT SP092112-1			WWW.MINITECFRAMING.COM	
DRAWN BY ANDY MOLES			VICTOR, NY	
DATE 12/10/2012			PH # 585 924-4690 DIRECT 585 398-1240 EXT 104 FX # 585 924-4821 amoles@minitecframing.com	
DRAWN FOR MINITEC'S CUSTOMER	TITLE ADD TITLE	DWG NO SP061512-1 DOOR	REV	
TOLERANCES UNLESS OTHERWISE NOTED X +/- .125" .XX +/- .015" .XXX +/- .010"		MATERIAL		SHEET 6 OF 7
		FINISH		



PROJECT SP092112-1			WWW.MINITECFRAMING.COM	
DRAWN BY ANDY MOLES			VICTOR, NY	
DATE 12/10/2012			PH # 585 924-4690 DIRECT 585 398-1240 EXT 104 FX # 585 924-4821 amoles@minitecframing.com	
DRAWN FOR MINITEC'S CUSTOMER	TITLE ADD TITLE	DWG NO SP121112-1 DOOR LEFT	REV	
TOLERANCES UNLESS OTHERWISE NOTED .X +/- .1/32" .XX +/- .015" .XXX +/- .010"		MATERIAL	FINISH	
			SHEET 7 OF 7	